

## Future Steel Vehicle

---

### Phase I - Executive Summary

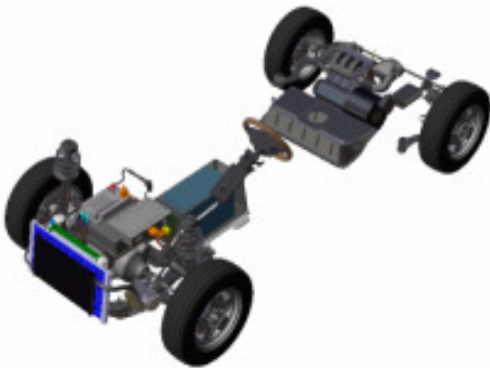
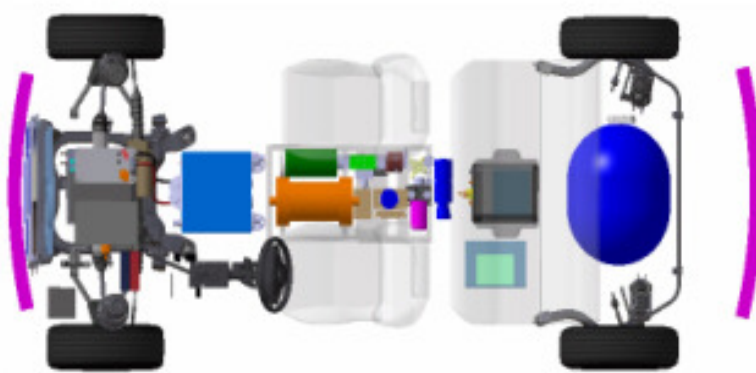

# Contents

<b>1</b>	<b>Executive summary</b>	<b>1</b>
1.1	Project Objectives	1
1.1.1	FSV Project Phases Overview	2
1.2	Vehicle Size & Powertrains	3
1.2.1	Vehicle Size	3
1.2.2	FSV Advanced Powertrain Options & Performances	4
1.3	Future Steel Vehicle Design & Layout	5
1.3.1	FSV Front-End	5
1.4	Future Steel Vehicle-1 (FSV-1)	7
1.4.1	FSV1 - (PHEV <sub>20</sub> )	7
1.4.2	FSV-1 - BEV	8
1.5	Future Steel Vehicle -2 (FSV-2)	9
1.5.1	FSV-2 (PHEV <sub>40</sub> )	9
1.5.2	FSV-2- FCEV	10
1.6	FSV - Estimated Masses	11
1.7	FSV Cost of Ownership	13
1.8	Environmental Impact	15
1.8.1	FSV Fuel Economy and CO <sub>2</sub> Emissions	15
1.9	Well-to-Pump Assessment	17
1.10	FSV-1 - Environmental Assessment	18
1.10.1	FSV-1 - Pump-to-Wheel CO <sub>2</sub> Emissions	18
1.10.2	FSV-1 - Well-to-Wheel CO <sub>2</sub> Emissions	19
1.11	FSV-2 - Environmental Assessment	20
1.11.1	FSV-2 - Pump-to-Wheel CO <sub>2</sub> Emissions	20
1.11.2	FSV-2 - Well-to-Wheel CO <sub>2</sub> Emissions	21
1.12	Technology Assessment	22
1.12.1	Future Advanced Powertrains Summary	22
1.12.2	Advanced Powertrain Technologies	23
1.12.3	Steel Technologies	29
1.12.4	Automotive Technology Assessment	32
1.13	Future Safety Requirements	35
1.14	Fuel Economy Requirements	36

## 1.0 Executive summary

### 1.1 Project Objectives

The future direction of the transportation industry is being influenced by an increasing demand for better fuel economy, and to reduce emissions that result in greenhouse gas induced global warming. Increasing vehicle efficiency and the use of alternate low-carbon content fuels will not only reduce petroleum consumption, but also decrease the carbon footprint associated with the burning of fossil fuels. The use of advanced powertrains will lead to an increased focus on vehicle weight reduction and hence, material selection.

This project will illustrate to WorldAutoSteel member companies, the new advanced powertrain technologies that are now being cultivated to fruition towards the year 2020 and beyond. In the Future Steel Vehicle program, EDAG's focus is on a holistic approach to the concept development of innovative vehicle layout and optimized vehicle architecture. The proposed designs will offer advanced high-strength, steel intensive solutions to answer the call of reduced weight vehicles, resulting in a lighter, more fuel and cost efficient vehicle that will reduce the carbon footprint associated with the growing automotive market. Use of advanced high-strength steels and the latest manufacturing processes, which reflect state-of-the-art or future trends, are the primary design objectives. The Future Steel Vehicle development program will focus on the achievement of future crash and safety requirements coupled with the demonstration of low CO<sub>2</sub> emissions, and affordability of a steel intensive vehicle architecture using advanced powertrain technologies.

The main objectives of the FSV program can be broken down into five goals, which encompass the use of advanced high-strength steels:

1. Identify advanced powertrains and their impact on vehicle architecture
2. Investigate steels capability to meet the structural needs of advanced powertrain vehicles
3. Investigate vehicle weight reduction potential with the use of Advanced High-Strength Steels (AHSS), advanced manufacturing processes, and the use of computer aided structural optimization
4. Understand the loads imposed by advanced powertrains on the vehicle structure, thus identifying the requirements for new grades of steel for optimized low-mass vehicle structural applications and design
5. Identify new opportunities for steel uses in advanced powertrains and related infrastructures

### 1.1.1 FSV Project Phases Overview

The Future Steel Vehicle program is split into the following three phases:

- Phase I: Engineering study (2008 - July, 2009)
- Phase II: Concept design (August, 2009 - 2010)
- Phase III: Demonstration of hardware (2010-2011)

The content of Phase 1 was a comprehensive assessment and identification of advanced powertrains and future automotive technology applicable to year 2020 high volume vehicle production. Other areas to be covered are the impact of future worldwide safety requirements, fuel efficiency mandates, and the total vehicle environmental impact. Worldwide, various countries are pursuing regulations of greenhouse gases and are assessing CO<sub>2</sub> emissions in terms of the Well-to-Wheel efficiency of advanced powertrains using alternate fuels such as electricity, hydrogen and bio-fuels. The deliverables from Phase 1 include complete vehicle technical specifications and vehicle layout showing major components of advanced powertrain modules, and engineering content, as shown in Figure 1.1.

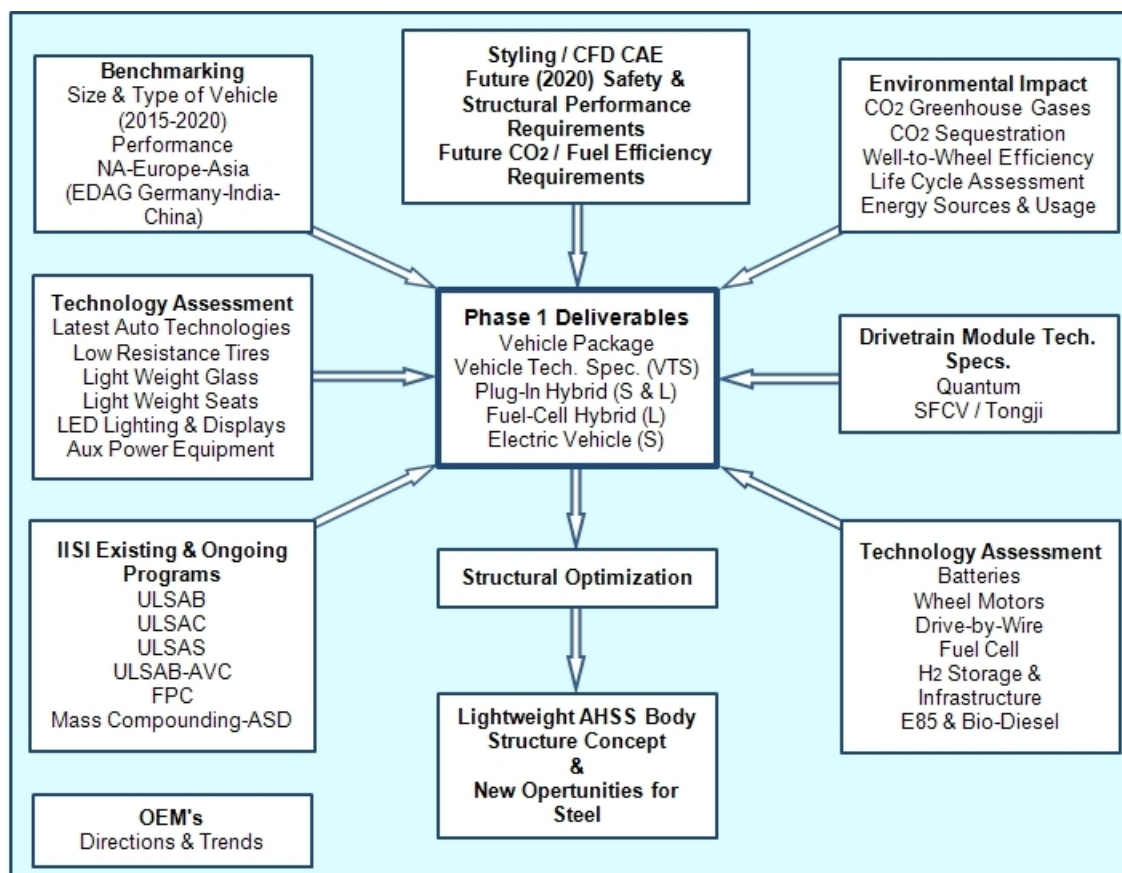

**Figure 1.1:** Phase 1 - Engineering study: content & methodology

## 1.2 Vehicle Size & Powertrains

### 1.2.1 Vehicle Size

Worldwide market analysis shows that over 70% of the cars sold in today's marketplace share two vehicle sizes: the small Car, (A & B Class) up to 4,000 mm long, and the mid-class car, (C & D class) up to 4,900 mm long. To encompass both segments of the worldwide market, the Future Steel Vehicle program includes two vehicle sizes, FSV-1 and FSV-2. The packaging specifications and vehicle performance for each of the vehicles were determined to be acceptable and appropriate for each class of vehicle, in line with worldwide OEM trends.

The determination of vehicle interior dimensions and luggage space requirements were based on each vehicle size and its intended usage. FSV-1 is a small vehicle mainly intended for city and shorter daily driving and, in terms of size, FSV-2 is at the low-end of the mid-size range of vehicles, intended for long range driving with larger luggage carrying capacity. The FSV-1 and FSV-2 layout and capacities are shown in Table 1.1.

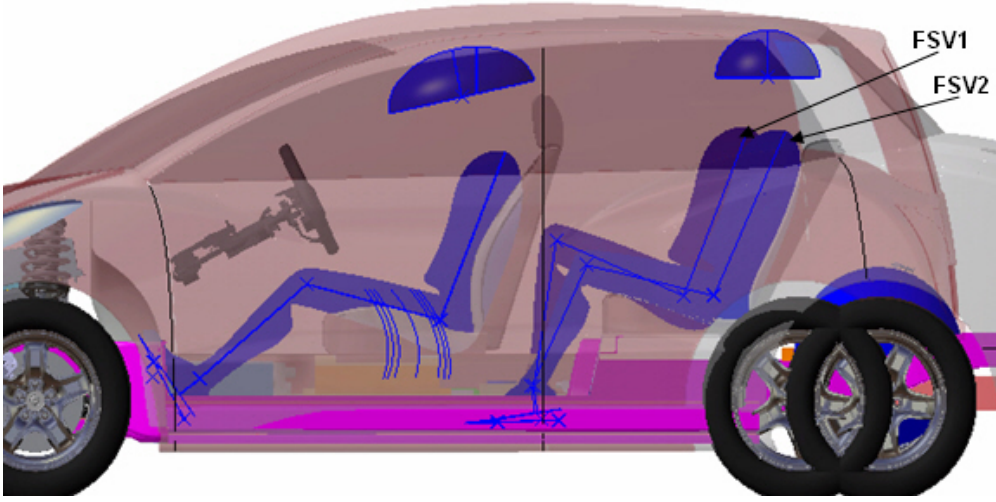
<b>FSV1 Occupants:</b>		<b>FSV2 Occupants:</b>	
Front Row Seating: 2		Front Row Seating: 2	
Rear Row Seating: 2+		Rear Row Seating: 3	
			
<b>Class</b>	<b>Front Leg Room [mm]</b>	<b>Rear Leg Room [mm]</b>	<b>Luggage [Liters]</b>
<b>FSV-1</b>	<b>1070</b>	<b>825</b>	<b>250</b>
<b>FSV-2</b>	<b>1070</b>	<b>925</b>	<b>370</b>
<b>A</b>	1055	760	170
<b>B</b>	1065	850	340
<b>C</b>	1070	877	370
<b>D</b>	1075	961	450

**Table 1.1:** FSV-1 and FSV-2 vehicle capacity

### 1.2.2 FSV Advanced Powertrain Options & Performances

The assessment of the announcements from automobile manufacturers shows progress on various technologies that include:

1. Conventional Internal Combustion Engine (ICE) based, smaller more efficient gasoline/diesel vehicles
2. Hybrid Electric Vehicles (HEV) predominantly using fossil-based petroleum fuels
3. Plug-in Hybrid Electric Vehicles (PHEV) with a limited range of distance driven in electric mode using electricity from the power grid. This option offers a significant reduction in fossil based petroleum usage, especially when the daily distances driven are close to the vehicle's electric range, with any additional distance driven using fossil based petroleum fuels
4. Battery Electric Vehicles (BEV) with a driving range of approximately 200 km
5. Fuel Cell Electric Vehicles (FCEV) using hydrogen gas as a fuel source

Assessment of year 2015 to 2020 powertrain component mass, cost and sizes were taken into account when determining the suitability of each powertrain for each vehicle size. The powertrains chosen for the smaller vehicle (FSV-1) included Plug-in Hybrid (PHEV<sub>20</sub>) and Battery Electric Vehicle (BEV). For the smaller car, the Fuel Cell Electric Vehicle (FCEV) powertrain was not implemented due to excessive cost and complexity involved with hydrogen storage and fuel stack installation. For the larger vehicle (FSV-2) the BEV option was not included due to the larger and more costly battery requirements for larger vehicles. The chosen powertrain options and performance parameters are shown in Table 1.2.

	<b>Plug-in Hybrid (PHEV)</b>	<b>Fuel Cell (FCEV)</b>	<b>Battery Electric (BEV)</b>
<b>FSV 1</b>	<b>PHEV 20</b> Electric Range - 32km (20mi) Total Range - 500km Max Speed -150km/h 0-100km/h 11-13s		<b>BEV</b>  Total Range - 250km Max Speed -150km/h 0-100km/h 11-13s
<b>FSV 2</b>	<b>PHEV 40</b> Electric Range - 64km (40mi) Total Range - 500km Max Speed - 161km/h 0-100km/h 10-12s	<b>FCEV</b>  Total Range - 500km Max Speed - 161km/h 0-100km/h 10-12s	

**Table 1.2:** *Powertrain options & performance*



### 1.3 Future Steel Vehicle Design & Layout

Results of technology assessment and powertrain component feasibility studies conducted by Quantum and Shanghai Fuel Cell Vehicles (SFCV), were used for vehicle layout studies. Several layouts were analyzed for each vehicle and powertrain for efficient usage of packaging space and vehicle mass distribution. For the two chosen vehicle sizes, it became apparent that a common platform theme can be developed, utilizing shared technologies in a modular fashion between the following four vehicle powertrain variants:

1. FSV-1 - Battery Electric Vehicle (BEV)
2. FSV-1 - Plug-In Hybrid Electric with a 32 km (20 mile) all-electric range (PHEV<sub>20</sub>)
3. FSV-2 - Plug-In Hybrid Electric with a 65 km (40 mile) all-electric range (PHEV<sub>40</sub>)
4. FSV-2 - Fuel Cell Hybrid Electric Vehicle (FCEV)

#### 1.3.1 FSV Front-End

Electrically driven front wheels, applicable to all the powertrains, simplify the front-end layout and leads to a significant reduction in vehicle front-end length. Drivetrains consisting of a traction motor, reduction gearing, and a differential as a combined unit, yield a more compact space efficient design, as compared to a conventional Internal Combustion Engine (ICE), as shown in Figure 1.2, and Figure 1.3.

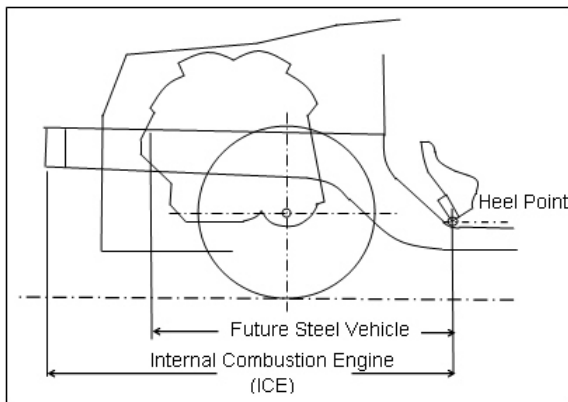

**Figure 1.2:** Conventional ICE front-end

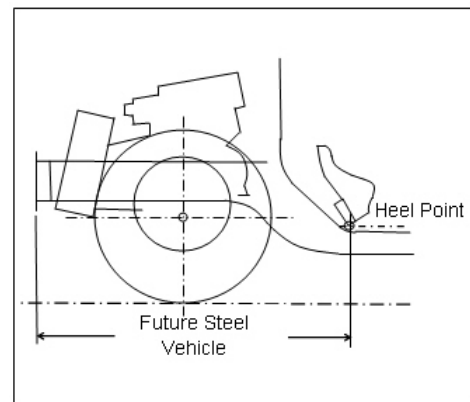

**Figure 1.3:** FSV Electric drive front-end

The FSV's front-end is 415 mm shorter than a typical mid-size sedan and 205 mm shorter than the 5-star rated Super-Mini class vehicles. The FSV-1 has a similar overall size as the Mini Cooper. However, the FSV-1 realizes 65 mm more legroom and has an additional 80 liters of cargo space. In comparison, the FSV-2 is 500 mm shorter than a Honda Accord, yet shares the same interior room.

The electric drive proposed for the FSV vehicles is similar to the drive used on the Honda Clarity FCEV as illustrated in Figure 1.4 <sup>[1]</sup>, yet much smaller.

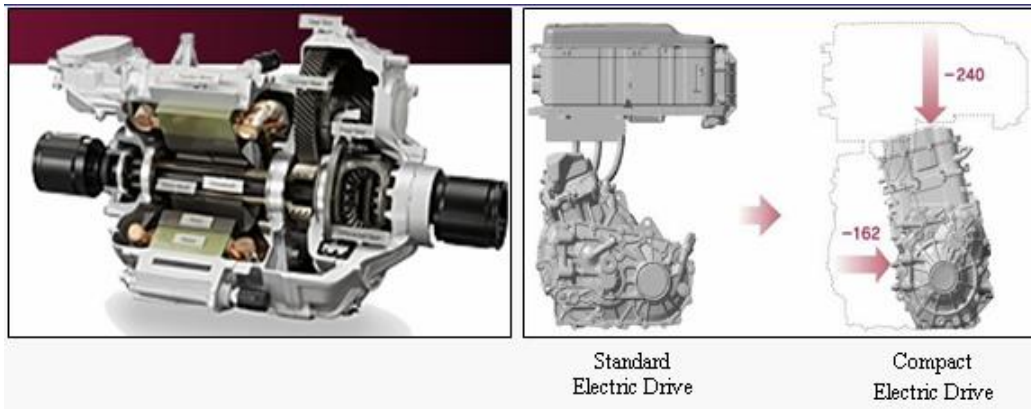

**Figure 1.4:** *Compact Electric Drive*

The size of conventional internal combustion engines, and HEV powertrains, generally restrict the size and shape of body structural members in the front-end, leading to an inefficient use of materials. The FSV front-end frees up space for an optimized front-end structure. The front-end rails, which play a major role in controlling and absorbing energy in front crashes, can be optimized for section shape and hence, minimizing mass. See Figure 1.5 for the front-end rail structure.

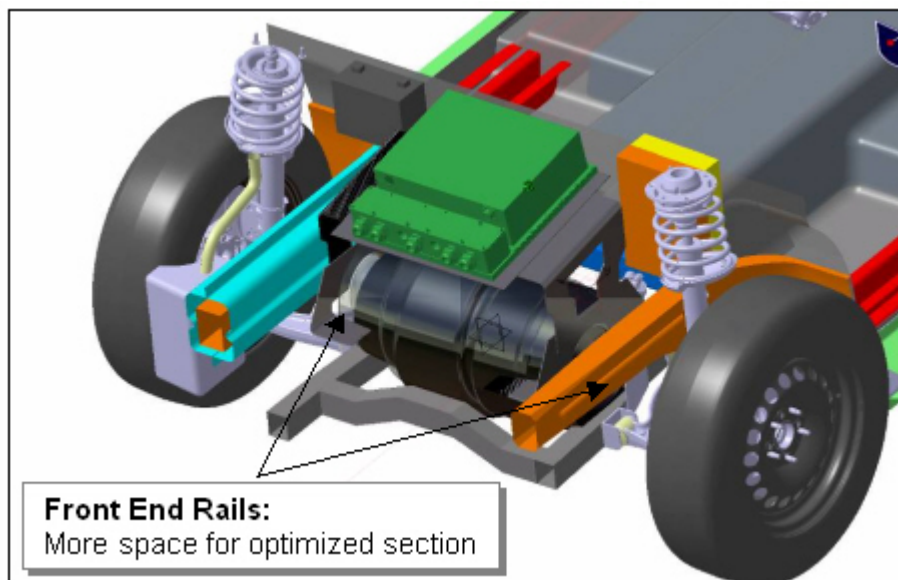

**Figure 1.5:** *Front-end rail*

<sup>1</sup>Source: Honda Motor Company



## 1.4 Future Steel Vehicle-1 (FSV-1)

FSV-1 is a 4-door hatchback, 3,700 mm long, designed to accept two powertrain options: Plug-In Hybrid Electric Vehicle - PHEV<sub>20</sub> and Battery Electric Vehicle - BEV. Both powertrains share a common front-end and common front wheel drive traction motor. The traction motor is rated at a peak power of 67 kW (49 kW continuous power).

### 1.4.1 FSV1 - (PHEV<sub>20</sub>)

The PHEV<sub>20</sub> will have an all-electric range of 32 km (20 miles) on a fully charged battery pack. The battery pack is a lithium-ion manganese based cell with a 5 kWh capacity (45 kg mass, 36-liter volume). The battery pack charging time, using a 110 V, 10 amp electric service is 3.4 hours (using 220 V/15 amp, is 1.1 hours). The extended range of 500 km for PHEV<sub>20</sub> is provided by a rear mounted 1.0L-3 cyl gasoline engine/generator set, mounted just ahead of the rear axle, leading to a 50/50 vehicle mass split between front and rear wheels. This packaging arrangement uses the space underneath the rear floor where conventional vehicles place the spare tire. The arrangement is similar to Daimler's Smart-For-Two and Mitsubishi's i-Minicar production vehicles. The FSV installation will be simpler, as the engine does not drive the wheels or any belt driven auxiliary devices.

The under floor structure for the PHEV<sub>20</sub> has to be adapted to accommodate the 5 kWh battery pack in the tunnel under the front floor. The engine/generator set mounted under the rear floor will require careful consideration for packaging the rear suspension, and sufficient structure to handle all the dynamic and rear impact crash loading. The layout for PHEV<sub>20</sub> is a rear sub-frame assembly that can support the engine/generator mounts, and rear multi-link suspension that will form the basis of the rear structure. See Figure 1.6 for PHEV<sub>20</sub> layout.

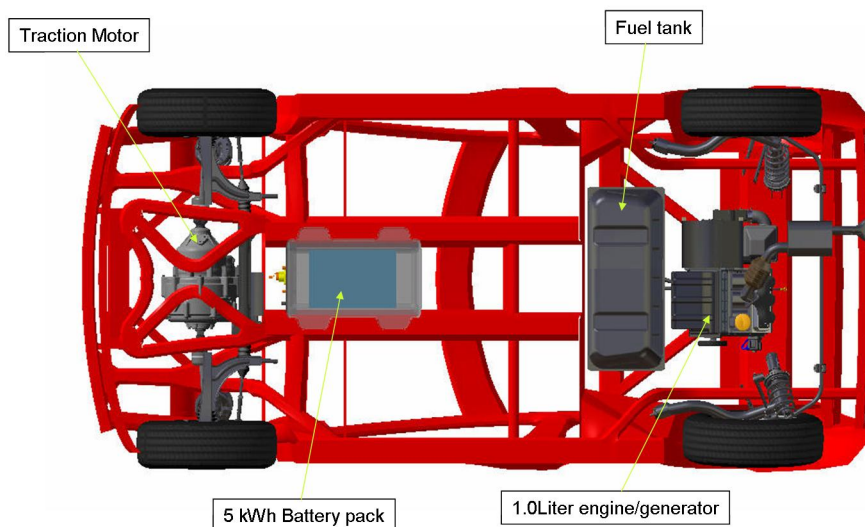

**Figure 1.6:** PHEV<sub>20</sub> powertrain layout

### 1.4.2 FSV-1 - BEV

The FSV-1 BEV is designed to have a range of 250 km. To achieve this range, the energy storage capacity of the battery pack has to be 35 kWh (347 kg mass, 280 liter volume). The charging time for this battery pack using a 110 V, 10 amp electric service is 23.9 hours (using 220 V/15 amp, is 8 hours). Packaging this size of a battery into a small vehicle is a major challenge. The battery extends forward from underneath the rear seat occupants floor into the tunnel and below the front floor. The under floor structures not only have to support the significant weight of the battery during road loading, but also protect it when subjected to frontal, side and rear crash impact loads. Presently, it is envisioned that a full-size under floor longitudinal member, coupled with several cross members and additional tunnel reinforcements, will be required, leading to a possible application for high-strength steel sections. See Figure 1.7 for BEV underbody.

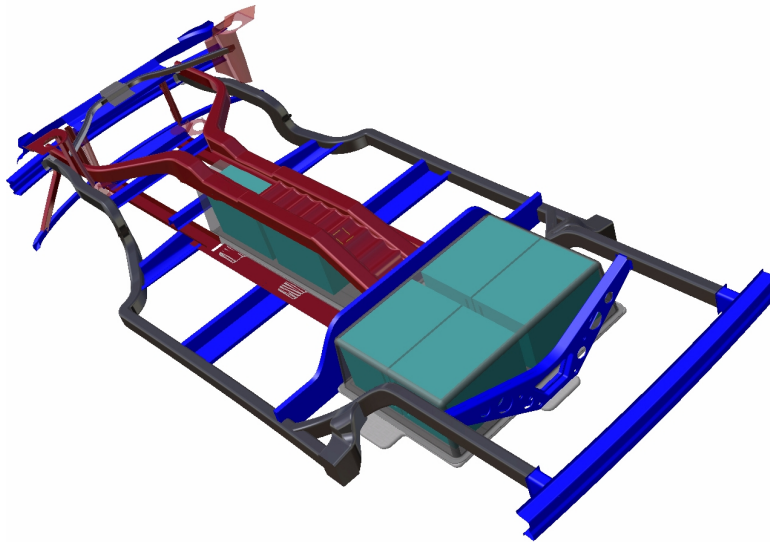

Figure 1.7: BEV underbody

## 1.5 Future Steel Vehicle -2 (FSV-2)

The FSV-2 is a 4-door sedan, 4,350 mm long, and designed to accept two powertrain options:

- A Plug-in Hybrid Electric Vehicle - PHEV<sub>40</sub>
- A Fuel Cell Electric Vehicle - FCEV

Both powertrains share a common front-end and a common front wheel drive traction motor package. The traction motors rated peak power is 75 kw (55 kw of continuous power).

### 1.5.1 FSV-2 (PHEV<sub>40</sub>)

The PHEV<sub>40</sub> vehicle will have an all-electric range of 64 km (40 miles) on a fully charged battery. The battery pack is a lithium-ion manganese based cell with a 11.7 kWh capacity (105 kg mass, 86 liter volume). The charging time for this battery pack using a 110 V, 10 amp electric service is 8 hours (using 220 V/15 amp, is 2.7 hours). A rear mounted 1.4 L - 4 cyl gasoline engine/generator set provides the PHEV<sub>40</sub> with an extended range of 500 km.

Presently, other driving strategies are being investigated that could considerably reduce the size of the engine/generator.

The component packaging and structural challenges for this vehicle are similar to the PHEV<sub>20</sub>. See Figure 1.8 for PHEV<sub>40</sub> illustration.

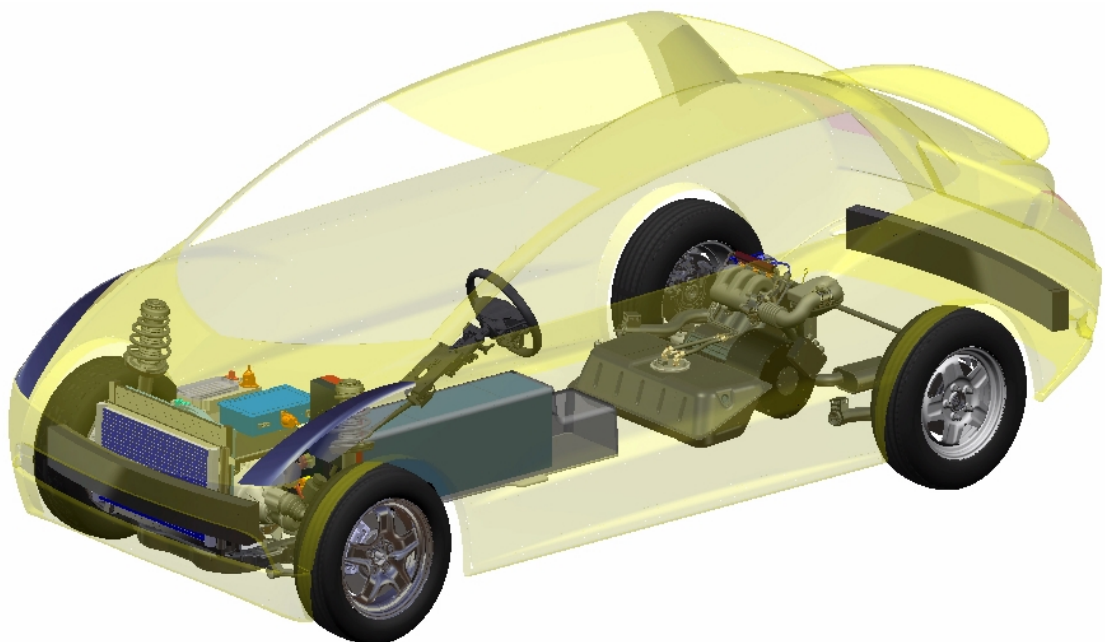

**Figure 1.8:** *FSV-2 (PHEV<sub>40</sub>)*

### 1.5.2 FSV-2- FCEV

The FCEV - Fuel Cell Electric Vehicle has an all-electric driving range of 500 km. The FCEV energy source is electricity generated by the hydrogen fuel cell system. A fuel cell is a device that uses hydrogen (or hydrogen-rich fuel) and oxygen to create electricity by an electro-chemical process. Fuel cells use the chemical energy of hydrogen to cleanly and efficiently produce electricity, with water and heat as by-products. See Figure 1.9 for FCEV illustration.

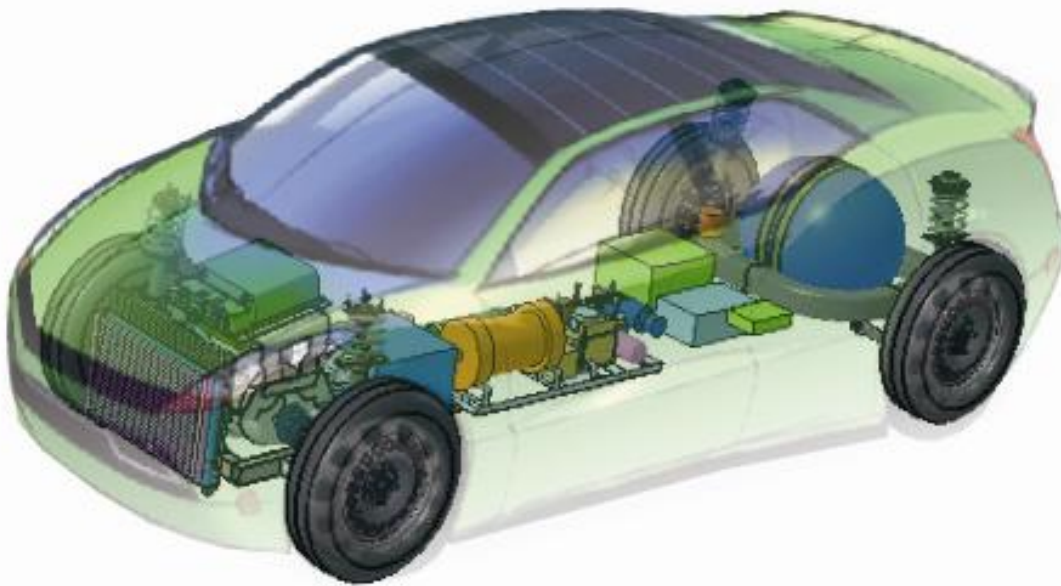













**Figure 1.9:** FSV-2 - FCEV

The FCEV has a usable hydrogen storage capacity of 3.4 kg, with an internal volume of 95 liters, that is stored at 65 Mpa at 15°C. The fuel-cell stack system has 240 cells, which has a combined weight of 92 kg producing 65 kW of power. The battery pack used in conjunction with this system is a lithium-ion manganese based cell with 2.3 kWh capacity, and weighs 27 kg with a 25-liter volume.













The challenges of the FCEV underbody structure is to provide sufficient support and protection to the fuel stack assembly packaged in the front floor tunnel, and the high-pressure hydrogen tank under the rear floor. The under body-structure will require extensive new structural members to meet stiffness requirements and crash loads.

## 1.6 FSV - Estimated Masses

The mass estimates, shown in Table 1.3 and Table 1.4 for FSV-1 and FSV-2 were based on the previously described vehicle layouts and calculated using the Mass Compounding Program.

		ICE 1 2010	ICE 1 2020	HEV 1 2010	HEV 1 2020	FSV 1 PHEV <sub>20</sub>	FSV 1 BEV
	Body Non-Structure	245	190	215	190	190	190
	Body Structure	272	241	272	237	173	190
	Front Suspension	59	40	62	45	40	45
	Rear Suspension	53	39	61	37	26	35
	Steering	17	17	17	17	16	16
	Brakes	38	31	40	33	29	32
	Drivetrain	222	197	297	252	215	78
	Fuel, Battery, Exhaust	48	55	104	105	98	347
	Wheels and Tires	78	59	68	55	38	44
	Air Conditioning	32	42	27	33	36	36
	Electrical	55	63	55	66	63	58
	Bumpers	26	21	23	24	20	23
	Closures	54	48	49	44	46	46
	<b>TOTAL</b>	<b>1199</b>	<b>1044</b>	<b>1290</b>	<b>1138</b>	<b>990</b>	<b>1,137</b>

**Table 1.3:** FSV-1 mass estimates (all in kg)

		ICE 2 2010	ICE 2 2020	HEV 2 2010	HEV 2 2020	FSV 2 PHEV <sub>40</sub>	FSV 2 FCEV
	Body Non-Structure	302	210	257	210	210	210
	Body Structure	337	298	337	303	198	175
	Front Suspension	73	49	76	55	51	44
	Rear Suspension	65	45	73	44	52	34
	Steering	21	21	21	21	19	19
	Brakes	47	37	49	40	37	34
	Drivetrain	274	244	359	304	261	177
	Fuel, Battery, Exhaust	59	68	125	127	178	114
	Wheels and Tires	96	72	80	73	70	61
	Air Conditioning	40	52	35	46	47	47
	Electrical	68	78	68	82	83	93
	Bumpers	33	25	31	28	26	22
	Closures	67	59	62	55	48	48
	<b>TOTAL</b>	<b>1,483</b>	<b>1,260</b>	<b>1574</b>	<b>1388</b>	<b>1279</b>	<b>1079</b>

**Table 1.4:** *FSV-2 mass estimates (all in kg)*

The powertrain component masses were obtained from simulations with PSAT (Powertrain System Analysis Toolkit) conducted by Quantum. The estimated masses of a similar (to FSV-1) sized ICE vehicle and a HEV (2010 and 2020) are also shown for comparison purposes.

The mass reductions that can be achieved by other future technologies, smaller vehicle foot print of FSV, and body-structure mass reduction by use of advanced high-strength steels, lead to significant mass reductions of the FSV.



## 1.7 FSV Cost of Ownership

The following costs were calculated based on vehicle total life of 200,000 km (125,000 miles). Other assumptions include:

- For PHEV<sub>20</sub> - 50% of distance traveled in electric mode, 50% of the distance traveled in HEV mode
- For PHEV<sub>40</sub> - 70% of distance traveled in electric mode, and 30% of the distance traveled in HEV mode
- Cost of electricity - \$0.12 per kWh
- Cost of gasoline - \$1.18 per liter (\$4.50 US per gallon)
- Cost of hydrogen gas - \$5.00 /kg, as currently charged by some stations in California on the Hydrogen Highway

As shown in Table 1.5, and Table 1.6, the advanced powertrains higher costs leads to significantly higher vehicle costs. However, the total cost of ownership is not significantly different between the various options except for FCEV, which is 26% higher.

	Petroleum Based				FSV-1 Dual Fuel Based Electricity form Grid and Petroleum			
	ICE 2020 18 $\frac{\text{km}}{\text{T}}$ (42.7 MPG)		HEV 2020 27.2 $\frac{\text{km}}{\text{T}}$ (64 MPG)		BEV - EV 114 $\frac{\text{Wh}}{\text{km}}$		PHEV <sub>20</sub> 106 $\frac{\text{Wh}}{\text{km}}$ & 26.7 $\frac{\text{km}}{\text{T}}$ (62.7 MPG)	
	[total \$]	[per km]	[total \$]	[per km]	[total \$]	[per km]	[total \$]	[per km]
<b>Vehicle Cost</b>	16,250	0.081	18,090	0.090	32,535	0.163	22,810	0.114
<b>Overhead</b>	6,094	0.030	6,094	0.030	6,094	0.030	6,094	0.030
<b>Vehicle Cost without Powertrain</b>	7,746	0.039	7,746	0.039	7,746	0.039	7,746	0.039
<b>Powertrain Cost</b>	2,350	0.012	3,350	0.017	2,945	0.015	6720	0.034
<b>Battery Cost</b>	60		900	0.005	15,750	0.079	2250	0.011
<b>Vehicle Use Cost</b>	14,097	0.070	9,738	0.050	2,731	0.014	6,232	0.030
<b>Gasoline</b> \$1.18 per l (\$4.50 per gal US)	13,097	0.065	8,738	0.044			4,460	0.022
<b>Oil Change \$40</b> \$40 per 8,000 km	1,000	0.005	1,000	0.005			500	0.003
<b>Electricity</b> \$0.12per kwh					2,731	0.014	1,272	0.006
<b>Total Cost of Ownership</b>	30,346	0.152	27,828	0.139	35,266	0.176	29,041	0.145

**Table 1.5: Cost of ownership, FSV-1**

	Petroleum Based				Hydrogen Gas Comp. 70 Mpa FCEV		Electricity & Petroleum PHEV <sub>40</sub>	
	ICE 2020 16 $\frac{\text{km}}{\text{l}}$ (38MPG)		HEV2020 19 $\frac{\text{km}}{\text{l}}$ (45MPG)		0.632 $\frac{\text{kgH}_2}{100 \text{ km}}$		119 $\frac{\text{Wh}}{\text{km}}$ & 20 $\frac{\text{km}}{\text{l}}$ (47 MPG)	
	[total \$]	[per km]	[total \$]	[per km]	[total \$]	[per km]	[total \$]	[per km]
<b>Vehicle Cost</b>	21,760	0.110	23,910	0.120	42,153	0.210	31,515	0.160
<b>Overhead</b>	8,160	0.041	8,160	0.041	8,160	0.041	8,196	0.041
<b>Vehicle Cost</b> without Powertrain	10,500	0.053	10,500	0.053	10,500	0.053	10,500	0.053
<b>Powertrain Cost</b>	3,100	0.016	4,350	0.022	22,458	0.112	7554	0.038
<b>Battery Cost</b>			900	0.005	1,035	0.005	5265	0.026
<b>Vehicle Use Cost</b>	15,717	0.080	13,427	0.070	6,320	0.030	5,869	0.030
<b>Gasoline</b> \$1.18 per l (\$4.50 per Gal US)	14,717	0.074	12,427	0.062			3,570	0.018
<b>Oil Change</b> \$40 Per 8050 km	1,000	0.005	1,000	0.005			300	0.002
<b>Electricity</b> \$0.12 per kwh							1,999	0.010
<b>Hydrogen</b> \$5.00 per kg					6,320	0.032		
<b>Total Cost of Ownership</b>	37,477	0.190	37,337	0.190	48,473	0.240	37,384	0.190

**Table 1.6:** *Cost of ownership, FSV-2*

For the BEV, comparatively lower energy cost of electricity leads to lower vehicle-use costs compared to the ICE-2020 (\$0.070 and \$0.014 per km traveled for gasoline and electricity respectively).

The fact that BEV and FCEV vehicle costs are almost double the cost of comparable internal combustion engine vehicles (ICE-2020), will lead to OEMs demands to reduce the powertrain cost as much as possible. The size of powertrain is directly related to the total mass of the vehicle, therefore the effect of mass reduction to powertrain cost was determined.

## 1.8 Environmental Impact

### 1.8.1 FSV Fuel Economy and CO<sub>2</sub> Emissions

The Pump-to-Wheel fuel economy and CO<sub>2</sub> emissions results achieved for all the FSV variants are well below the future worldwide requirements, as shown in Table 1.7. The most stringent future proposed requirement for CO<sub>2</sub> emissions in the European Union (EU) is 95  $\frac{\text{g}(\text{CO}_2)}{\text{km}}$  (passenger car fleet average), to be met by year 2020. The Pump-to-Wheel emissions for the BEV and FCEV are zero. Vehicles with these powertrains, are classed as Zero Emissions Vehicles (ZEV) by the California Air Resources Board (CARB). The CO<sub>2</sub> emissions for PHEV<sub>20</sub> and PHEV<sub>40</sub> are 23  $\frac{\text{g}(\text{CO}_2)}{\text{km}}$  and 27  $\frac{\text{g}(\text{CO}_2)}{\text{km}}$  respectively, assuming these vehicles will be driven in BEV mode for 70% of the miles driven. Currently, there is no agreed methods for measuring the fuel economy of PHEV vehicles. It will most likely be based on how much petroleum the PHEV is saving by using electricity from the grid, (“Petroleum Displacement” method).

	FSV1		FSV2		Reg. Limit ALL
	BEV	PHEV <sub>20</sub>	FCEV	PHEV <sub>40</sub>	
European Drive Cycle (NEDC)					
CO2 Emissions g/km	0	23	0	27	95
Fossil Fuel l/100km	0	0.99	0	1.14	4.1
Electricity Usage $\frac{\text{Wh}}{\text{km}}$	89	65	0	75	N/A
Total Energy Usage ** $\frac{\text{Wh}}{\text{km}}$	89	152	211	175	361
2008 US EPA Drive Cycle					
CO2 Emissions (combined) g/km	0	31	0	35	156
Combined MPG	∞	177	∞	157	35
Combined Electricity Usage $\frac{\text{Wh}}{\text{km}}$	109	80	0	92	N/A
Combined Energy Usage ** $\frac{\text{Wh}}{\text{km}}$	109	196	295	224	590
City MPG	∞	177	∞	157	N/A
City Electricity Usage $\frac{\text{Wh}}{\text{km}}$	103	75	0	86	N/A
City Energy Usage ** $\frac{\text{Wh}}{\text{km}}$	103	192	304	218	N/A
Highway MPG	∞	177	∞	157	N/A
Highway Electricity Usage $\frac{\text{Wh}}{\text{km}}$	117	85	0	99	N/A
Highway Energy Usage ** $\frac{\text{Wh}}{\text{km}}$	117	202	295	231	N/A

\* Based on Petroleum Displacement method

\* Assumption: 70% in EV modes & 30% in Charge Sustaining modes

\*\* Combined fuel energy plus stored electrical energy

**Table 1.7:** FSV fuel economy and CO<sub>2</sub> emissions table

Figure 1.10 from “Japan - Ministry of Land, Infrastructure, Transport and Tourism” shows how the FSV CO<sub>2</sub> emissions compared with other gasoline, diesel and HEV vehicle technologies. As can be seen, the FSV’s emissions are very close to being in the ZEV class of vehicles.

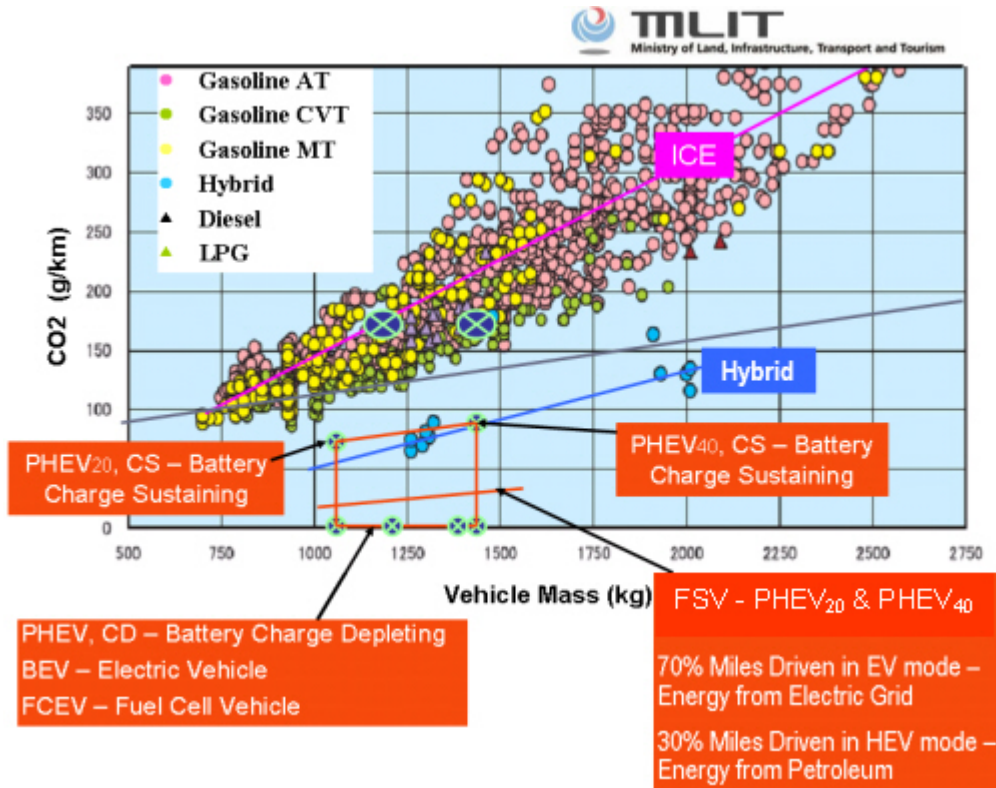

**Figure 1.10:** FSV fuel economy and CO<sub>2</sub> emissions

It is interesting to note the slope of each technologies data set in the above graph for ICE, HEV, and FSV are progressively trending lower, indicating proportionally lower CO<sub>2</sub> emissions as indicated by the slope of the line, with respect to proportional mass increases, (not to be confused with total mass increases). This is mainly due to future vehicles using regenerative braking systems, whereas the ICE system can not utilize regenerative braking. The FSV has the most effective regenerative braking system due to having a higher power electric motor and larger capacity battery, when compared to the less effective units in the HEV’s.

## 1.9 Well-to-Pump Assessment

The Well-to-Pump assessment for all possible future sources of FSV vehicle fuels was done using Argonne National Lab programs “Greet 1.8B”. The sources of energy (fuels) considered included the following:

- Electricity (US mix, Europe, China, Japan, India, 100% coal and 100% renewable)
- Gasoline and diesel from petroleum
- Bio-fuels, ethanol and bio-diesel
- Hydrogen gas and liquid made using electrolysis process and from natural gas

Table 1.8 shows electricity generation efficiencies, CO<sub>2</sub> and other emissions during electricity production using various feed-stocks. These results are used to calculate the “Well-to-Wheel” energy quantities shown in results for the FSV in the following section.

Feedstocks [%]	USA	Europe	China	Japan	India	Coal	USA Green Mix
<b>Coal</b>	50.7	29.5	79	28.1	68.7	100	0
<b>Natural Gas</b>	18.9	9.9	0	21	8.9	0	0
<b>Oil</b>	2.7	4.5	2.4	13.2	4.5	0	0
<b>Nuclear</b>	18.7	31	2.1	27.7	2.5	0	20
<b>Biomass</b>	1.3	2.1	0	0	0	0	0
<b>Others</b>	7.7	13	16.5	10	15.4	0	80
	100	100	100	100	100	0	100
<b>Electricity Pathway:</b>							
<b>Efficiency [%]</b>	37.9	44.2	35	41.6	35.1	30.7	91.5
<b>CO2 [g/kWh]</b>	750.6	520.3	973	596.7	923.5	1201.3	0
<b>VOC [g/kWh]</b>	0.07	0.05	0.08	0.06	0.08	0.09	0
<b>Nox [g/kWh]</b>	0.82	0.61	1.05	0.76	1.01	1.26	0
<b>Sox [g/kWh]</b>	1.8	1.25	2.64	1.74	2.46	3.15	0

**Table 1.8:** *Well-to-Pump results (electricity generation)*

### 1.10 FSV-1 - Environmental Assessment

#### 1.10.1 FSV-1 - Pump-to-Wheel CO<sub>2</sub> Emissions

The Pump-to-Wheel CO<sub>2</sub> emissions for each FSV vehicle is shown in Figure 1.11. The limit of 95  $\frac{g(CO_2)}{km}$  shown in the figure, is the CO<sub>2</sub> regulation proposed for the European Union to come into effect by 2020.

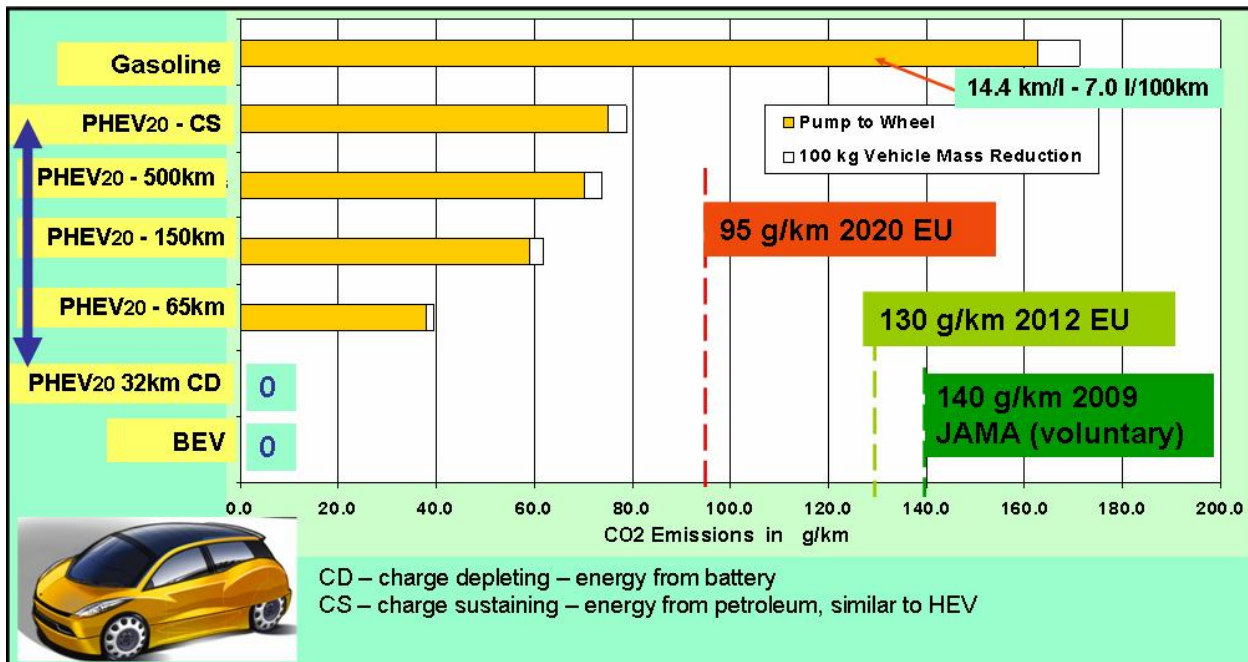

Figure 1.11: FSV-1 Pump-to-Wheel CO<sub>2</sub> emissions

The gasoline representative baseline vehicle shown in Table 1.11 is a conventional vehicle with a gasoline powered internal combustion engine. For each PHEV, both Charge Sustaining (CS) and Charge Depleting (CD) all-electric driving modes are also shown. On a Pump-to-Wheel basis, all four FSV Powertrain variants will emit less than 95  $\frac{g(CO_2)}{km}$ . The PHEVs and BEV produce zero CO<sub>2</sub> from the tailpipe when driven in all-electric mode.



1.10 FSV-1 - Environmental Assessment

1.10.2 FSV-1 - Well-to-Wheel CO<sub>2</sub> Emissions

There are also CO<sub>2</sub> emissions from the production of fossil fuels, renewable fuel, or electricity. So a Well-to-Wheel analysis is very important for a comprehensive evaluation of vehicle emissions. Adding the Well-to-Pump emissions factor to each vehicle, the Well-to-Wheel CO<sub>2</sub> emissions are attained, as shown in Figure 1.12. It can be observed that the PHEV in Charge Depleting, all-electric mode, and the BEV have zero tailpipe CO<sub>2</sub> emissions. However, their carbon footprint is not zero due to emissions from the production of fuel.

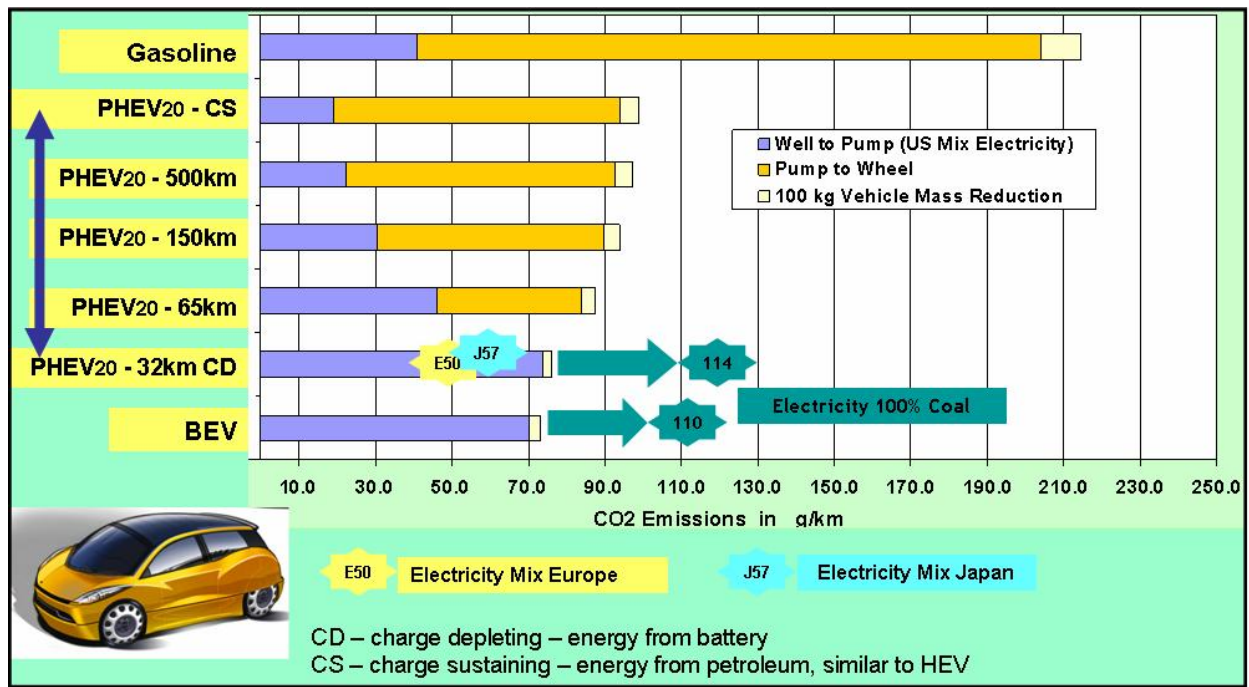

Figure 1.12: FSV-1 Well-to-Wheel CO<sub>2</sub> emissions

### 1.11 FSV-2 - Environmental Assessment

#### 1.11.1 FSV-2 - Pump-to-Wheel CO<sub>2</sub> Emissions

An environmental assessment of FSV-2 was also conducted using the Well-to-Wheel CO<sub>2</sub> emissions. The results of the assessment are shown in the Figure 1.13 and Figure 1.14.

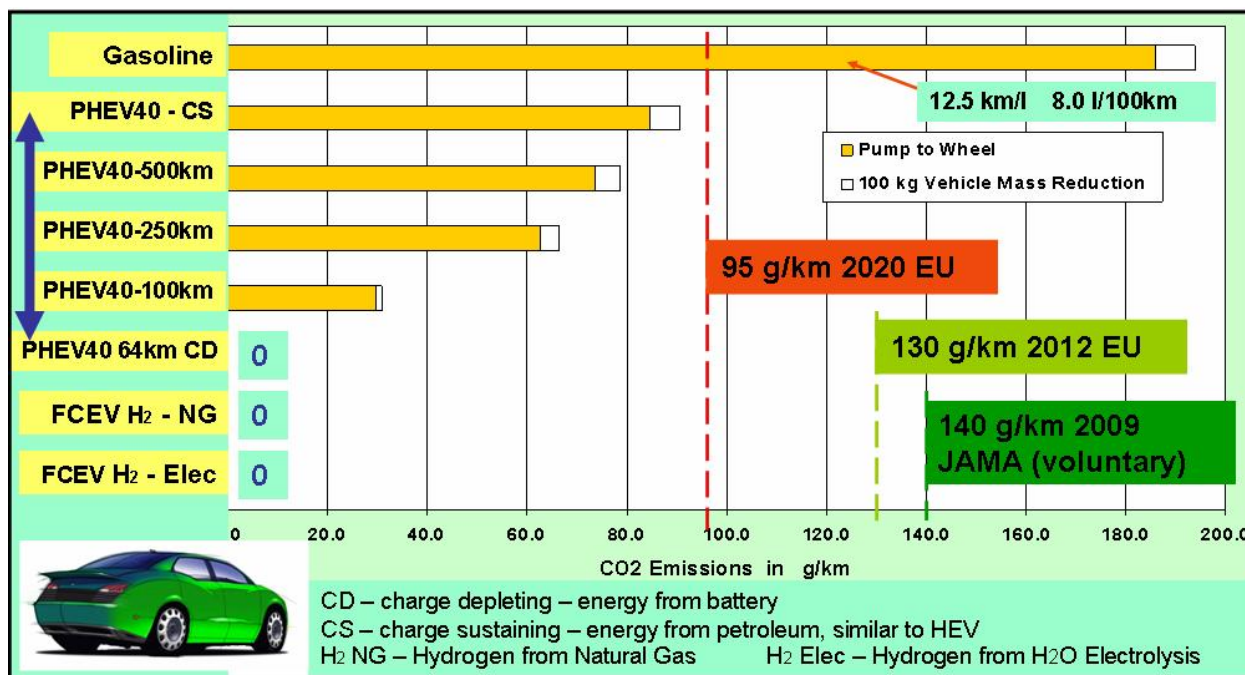
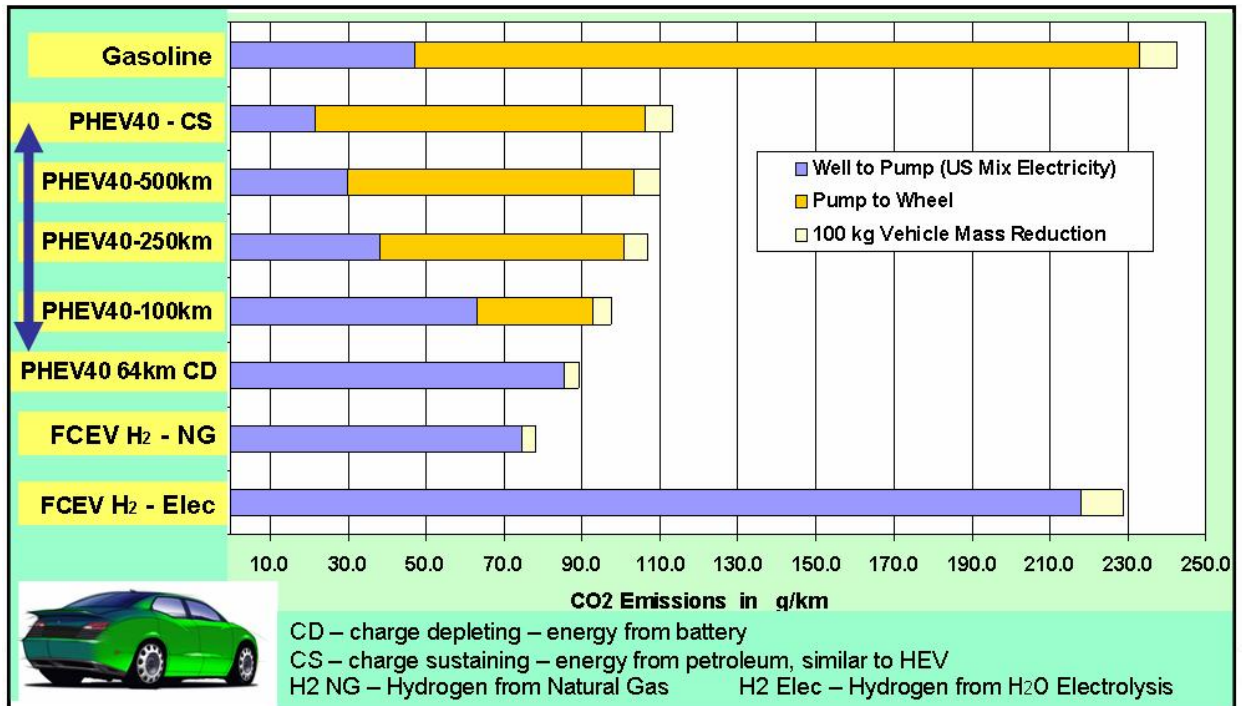

Figure 1.13: FSV-2 Pump-to-Wheel CO<sub>2</sub> emissions

1.11.2 FSV-2 - Well-to-Wheel CO<sub>2</sub> Emissions

 Figure 1.14: FSV-2 Well-to-Wheel CO<sub>2</sub> emissions

Even though FCEV (H<sub>2</sub>-NG) and FCEV (H<sub>2</sub>-elec) have zero tailpipe CO<sub>2</sub> emissions, their carbon footprint is not zero due to CO<sub>2</sub> emissions from production of their respective energy source. The H<sub>2</sub> FCEV Well-to-Wheel CO<sub>2</sub> emissions has a strong dependence on where its hydrogen comes from. In the best case scenario, it is only marginally better than the PHEV<sub>40</sub> operating in Charge Sustaining mode. It is envisioned that in the 2015 - 2020 time frame, electrical power available for FCEV H<sub>2</sub> electrolytic hydrogen production will come from the utility grid much like today's PHEVs, (power generation infrastructure will not evolve rapidly) and its carbon footprint will be much greater than any of the other PHEV variants.

## 1.12 Technology Assessment

### 1.12.1 Future Advanced Powertrains Summary

A feasibility study was performed to determine the powertrain architectures, components, performance, cost, and mass of four powertrain variants predicted to be in volume production by major automotive OEMs in the 2015-2020 timeframe. The study included the evaluation of currently used as well as emerging powertrain technologies. These include high voltage batteries of varying chemistries, ultra-capacitors, traction and wheel motors, and power electronics, as well as hydrogen storage and infrastructure.

For the purpose of the Future Steel Vehicle studies, a common transaxle sub-assembly consisting of a traction motor, reduction gearing, and differential, were selected. Two different power internal combustion engine/generator assemblies can electrically power the transaxle sub-assembly, by a fuel cell system, or by a large capacity high voltage battery. Each of these powertrain options has its unique fuel storage capacity, high voltage battery size, weight, and cooling configurations resulting in a new body-structure design and challenges.

For the complex fuel cell system, Shanghai Fuel Cell Vehicles (SFCV) performed a separate powertrain sub-system study in conjunction with Tongji University. The integration studies of the fuel cell sub-system into the vehicle powertrain systems were supported jointly by Quantum Technologies and SFCV. The cost, mass, fuel consumption, and Green-House-Gas (GHG) emission values (Pump-to-Wheel) for the different FSV vehicles are summarized in Table 1.9.

	Mass [kg]	2015 Cost [\$ US]	Consumption, Urban Dynamometer Driving Schedule			
			Depleting Electricity [ $\frac{Wh}{km}$ ]	Charge Sustaining		Greenhouse Gas (Pump-to-Wheel) [ $\frac{g\ CO_2}{km}$ ]
				Gasoline [ $\frac{L}{100\ km}$ ]	Hydrogen [ $\frac{Kg}{100\ km}$ ]	
<b>BEV</b>	449	18.695	88.9	0	0	0
<b>FCEV</b>	326	23.493	N/A	0	0.632	0
<b>PHEV<sub>40</sub></b>	469	12.819	107	3.81	0	88.6
<b>PHEV<sub>20</sub></b>	343	8.970	92.5	3.31	0	76.9

**Table 1.9:** Powertrain mass, cost, fuel consumption, and GHG emissions

As a general conclusion, costs of battery technology, fuel cell engines, and hydrogen fuel storage are the greatest challenges. Battery costs are predicted to reduce quicker than both fuel cell and hydrogen storage technology, therefore for 2015 - 2020, PHEV and BEV vehicles will have the highest probability of large volume market acceptance. FCEV vehicles will likely not be in volume production before 2020 and possibly later if cost reductions take longer.

### 1.12.2 Advanced Powertrain Technologies

Five major topics considered in the evaluation and use of advanced powertrain technologies are:

1. Battery technology
2. Fuel cell technology
3. Electric motors
4. Internal combustion engines
5. Advanced powertrain energy sources

#### 1.12.2.1 Battery Technology Assessment

Battery technologies currently used and under development for hybrid or full electric automotive applications are:

- Nickel Metal Hydride (Ni-MH) - today's mainstream battery technology for automotive traction applications
- Lithium-Ion

In the past 10 years, rechargeable battery energy storage capacities have been rapidly improved upon and costs have been relatively stable due to mature manufacturing processes for consumer products. This is realized by the increase demand in new technologies for consumer products, (cell phones, power tools, etc.). Many of these technologies have proven themselves with excellent product performance and reliability records.

Manufacturing cost and energy storage capacity advantages have caused an industry shift from Ni-MH to Li-Ion battery technology, thus allowing OEM application specific deployment of new chemistry and cylindrical or prismatic cells.

Automotive high-voltage battery technology is typically utilizing this mass production technology for cylindrical cells, which are connected in series (strings) and parallel, to achieve the voltage levels and desired storage capacity. However, these high-voltage energy batteries require safety measures for crash and service.

Temperature control of individual cells and battery packs as a whole has proven to be one of the key areas for automotive battery development in order to increase durability and provide acceptable operation performance under extreme climate conditions (i.e. cold-start or continuous high output at high ambient temperatures).

Ongoing product development and validation cycles paralleled with the ramp-up of manufacturing capacity for large batteries for PHEV deployment is expected in the years 2015 to 2020. However, substantial ongoing marketing activity for prototype technology may not be as rapidly turned into large volume production as might be anticipated. Therefore, new market incentives may be required to offset the high cost of large capacity batteries for plug-in and all-electric vehicle applications.

For phases 2 and 3 of the FSV program, the FSV engineering team recommends the use of battery technology because it is safe, energy and cost efficient, and lightweight. For the 2015 and forward timeframe, lithium-ion batteries using manganese oxide technology shows great potential to meet those requirements. See Table 1.10 for FSV battery recommendations.

<b>Battery Technology Assessment</b>				
		<b>Status 2008</b>	<b>Prediction 2015-2020</b>	<b>Selection FSV</b>
<b>Dominating Technology</b>		Ni-MH	Li-Ion	Li-Ion
<b>Power Density</b>	kW/kg	1.1	1-4	2.5
<b>Energy Density</b>	Wh/kg	45	90 - 170	130

<b>Battery Pack Technology Assessment</b>				
<b>Capacity</b>	kWh	10 (max)	1.5 - 40	2.3 - 35
<b>Cost</b>	\$ USD/ kWh	500	400-700	450

<b>Future Steel Vehicle Concept</b>				
	<b>Capacity (kWh)</b>	<b>Weight (kg)</b>	<b>Volume (Liters)</b>	<b>Cost* (\$ USD)</b>
<b>PHEV<sub>20</sub></b>	5	58.2	47	\$2,350
<b>PHEV<sub>40</sub></b>	11.7	136.5	103	\$5,365
<b>BEV</b>	35	346.5	280	\$15,850
<b>FCEV</b>	2.3	27.3	25	\$1,035

\* Cost shown is for the battery system including battery controller and plug-in charging system

**Table 1.10:** *Battery recommendation for FSV*



### 1.12.2.2 Fuel Cell Technology Assessment

The Shanghai Fuel Cell Vehicle Company (SFCV) in cooperation with Tongji University, Shanghai China, studied the fuel cell engine, its sub-systems, and its components separately.

The fuel cell engine technical assessment results and recommendations were documented in separate reports that are part of the combined Future Steel Vehicle Phase 1 effort. Close attention was given to integration of those results into the vehicle and powertrain packaging, weight and costs analysis. The necessary fuel cell engine performance parameters, established to meet vehicle performance requirements were co-developed with Quantum Technologies while utilizing the Powertrain System Analysis Toolkit (PSAT).

In recent years, fuel cell system development has proven more challenging in solving the technical and commercial viability of a large-scale production deployment. Substantial efforts are still required in cost efficient on-board hydrogen storage as well as fuel cell engine development. Integration of hydrogen fuel cell and storage technology in existing vehicle platforms yields unsatisfactory vehicle packaging compromises leading to potential consumer dissatisfaction.

Large-scale production volumes to justify dedicated hydrogen fuel cell vehicle platforms cannot be achieved due to high manufacturing cost and unfavorable market pricing of such vehicles. Therefore, published production forecasts are based either on limited short and mid-term plans published by OEMs, or far reaching estimates by industry and financial analysts. In either case, fuel cell vehicle production by 2015 and 2020, is going to be very limited compared to overall vehicle production. See Figure 1.15 for fuel stack assembly. The fuel cell recommendations for the FSV program is shown in Table 1.11.

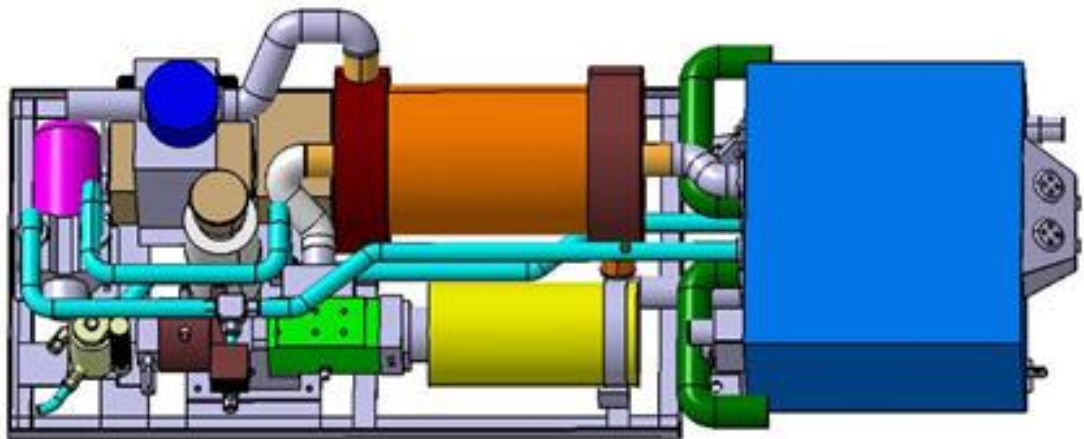

Figure 1.15: Fuel stack assembly

<b>Fuel Cell Technology Assessment</b>				
		<b>Status 2008</b>	<b>Prediction 2015-2020</b>	<b>Selection FSV</b>
<b>Dominating Technology</b>		PEM*	PEM*	PEM*
<b>Power Output (net)</b>	kW	40 - 100	50 - 170	65
<b>Efficiency</b>	%	45 - 56	50 - 62	50 - 62
<b>Power Density</b>	kW/kg	0.8 - 1.9	~2.0	2
<b>Cost [\$USD]</b>	\$ USD/ kW	1,500-2,900	~100 - 200	155

<b>Hydrogen Storage Technology Assessment</b>				
		<b>Status 2008</b>	<b>Prediction 2015-2020</b>	<b>Selection FSV</b>
<b>Dominating Technology</b>		Compressed Gas		Compressed
<b>Pressure</b>	MPa	35	50 - 70	70
<b>Tank Material</b>	Carbon Composite	Aluminum Liner	Plastic Liner	Plastic Liner
<b>H<sub>2</sub>O Volume Capacity</b>	Liters	80 - 220	70 - 150	95
<b>Hydrogen Capacity (net)</b>	kg	1.7 - 5.0	1.6 - 5.4	3.4

<b>Future Steel Vehicle Concept</b>				
	<b>Capacity (net)</b>	<b>Weight [kg]</b>	<b>Volume [Liters]</b>	<b>Cost [\$ USD]</b>
Without Cooling System				
<b>Fuel Cell Engine</b>	65 kW	92	67	\$10,081
<b>Hydrogen Storage</b>	3.4 kg	87	120	\$7,919

\* Polymer Electrolyte Membrane

**Table 1.11: Fuel cell recommendation for FSV**

### 1.12.2.3 Electric Motor Technology Assessment

Electric motor development is shifting from industrial designs to meet customized automotive durability, weight, and cost requirements. Electrification of powertrains, allows fossil fuel energy recovery for a substantial reduction in fuel consumption and CO<sub>2</sub> emissions. However, plug-in technology requires bigger electric motors and battery capacity suitable for all-electric operation in normal drive cycles.

Electric motors/generators are very efficient relative to an ICE, but they are at their maximum operating efficiency only in a narrow rpm range. Electric motor efficiency improvements are primarily extending the efficient operating range and power density. By focusing on magnet arrangement and coil designs, motor efficiency is optimized for the operating range the unit will be spending most of its service life in. For larger speed ranges, multi-speed transmissions are typically used, especially if the motor is used as an auxiliary power supply in typical hybrid vehicle configurations. If the motor is required to provide full traction power, a single speed gear reduction may be sufficient.

Electric motor/generators are closely coupled with DC power inverter hardware and software for optimized performance, efficiency and electro-magnetic emission resistance. For power and speed regulation, permanent magnets are used to electronically commutate (converts alternating electric current to direct current or vice versa) using variable voltage and variable frequency.

To ensure optimized efficiency of the generator and traction motors, the motor manufacturer matches the set to their respective power inverters. High efficiency allows the simplification or complete elimination of transmissions in series architectures based on performance, weight, cost and packaging considerations. The integrated traction drive concept, (series integrated generator/traction motor set without a transmission), offers the best compromise for the Future Steel vehicle. With internal scaling of the motor, the size of the motor components are engineered to operate at their maximum efficiency for the mass and power requirements of the vehicle application. By using internal scaling of the motor in addition to optimal gear reductions, it will be possible to support a modular powertrain design concept, and therefore reduce development and potential tooling cost at the same time. The recommendations for the FSV program are summarized in Table 1.12.

	Units	Current	BEV	PHEV <sub>20</sub>	FCEV	PHEV <sub>40</sub>
<b>Peak Power</b>	kW	Varies	67	67	75	75
<b>Continuous Power</b>	kW	Varies	49	49	55	55
<b>Max Torque</b>	Nm	Varies	270	270	240	240
<b>Max Efficiency</b>	%	95	96	96	95	95
<b>Specific Cost</b>	\$/kW	40	26	26	26	26
<b>Specific Power</b>	kW/kg	1.2	1.63	1.63	1.63	1.63
<b>Specific Power</b>	kW/l	3.2	4.8	3.3	3.3	3.3
<b>Physical Volume</b>	l	Varies	14	14	23	23

**Table 1.12:** Electric motor recommendations for FSV

### 1.12.2.4 Advanced Internal Combustion Engines

Internal combustion engine technology is a mature technology with incremental potential for efficiency improvements. The current fuels of choice for the light-duty vehicle market are gasoline and diesel, used with their respective engine type (Otto and Diesel Cycle). See Table 1.13 for internal combustion engine recommendations for FSV.

<b>PHEV<sub>20</sub></b>	<b>PHEV<sub>40</sub></b>
1.0 L , 3-cylinder , water cooled	1.4 L , 4-cylinder , water cooled
Gasoline fuel	Gasoline fuel
Normally aspirated	Normally aspirated
Direct fuel injection	Direct fuel injection
50 kW peak power	70 kW peak power
Cylinder orientation tilted to approach horizontal	Cylinder orientation tilted to approach horizontal
Torque and power curves matched with generator for maximum fuel efficiency and CO <sub>2</sub> emission reduction	Torque and power curves matched with generator for maximum fuel efficiency and CO <sub>2</sub> emission reduction
All accessories electric powered (no belt drive)	All accessories electric powered (no belt drive)
Generator used for engine start (no starter motor required)	Generator used for engine start (no starter motor required)

**Table 1.13:** *Internal combustion engine recommendations - PHEV<sub>20</sub> and PHEV<sub>40</sub>*

### 1.12.3 Steel Technologies

A number of steel forming technologies will be adopted for the Future Steel Vehicle (FSV) to take advantage of the benefits of Advanced High Strength Steel (AHSS). Use of these steels result in a substantial mass savings by a reduction in material thickness with an increase in strength and part performance.

The WorldAutoSteel-FSV steel portfolio will be utilized during the material selection process with the aid of full vehicle analysis to determine material grade and thickness. The available steel ranges from “mild steel” to advanced high strength “martensitic steel”. The basic types are the following:

- Mild (Mild steel)
- BH (Bake Hardenable)
- IF (Interstitial Free)
- DP (Dual Phase)
- CP (Complex Phase)
- SF (Stretch Flange)
- FB (Ferrite Bainite)
- HT (Heat Treatable)
- HSLA (High Strength Low Alloy)
- TRIP (Transformed Induced Plasticity)
- MS (Martensitic)
- MnB (Boron)
- LIP (Light Induced Plasticity)

The full range of steels available for the Future Steel Vehicle is shown in Table 1.14.

Item #	Steel Grade	Thickness (mm)		Gauge Length	YS (Mpa)	YS (Mpa)	UTS (Mpa)	UTS (Mpa)	Tot EL (%)	N-value
		Min t	Max t		Min	Typical	Min	Typical	Typical	Typical
1	Mild 140/270	0.6	2.3	A50	140	150	270	300	38-44	0.23
2	BH 210/340	0.64	2.79	A50	210	230	340	350	35-41	0.19
3	BH 260/370	0.64	2.79	A50	260		370		32-36	0.17
4	IF 260/410	0.6	2.3	A50	260	280	410	420	34-48	0.20
5	BH 280/400	0.6	2.8	A50	280	324	400	421	30-34	0.16
6	IF 300/420	0.6	2.3	A50	300		420		29-36	0.20
7	DP 300/500	0.5	2.5	A80	300	345	500	520	30-34	0.16
8	FB 330/450	1.8	3.0	A80	330	380	450	490	29-33	0.17
9	HSLA 350/450	0.5	3.0	A80	350	360	450	470	23-27	0.16
10	DP 350/600	0.6	2.5	A80	350	385	600	640	24-30	0.19
11	TRIP 350/600	0.6	2.3	A50	350	400	600	630	29-33	0.20
12	DP 400/700	1.27	3.2		400		700		19-25	0.14
13	TRIP 400/700	1.0	1.6		400		700		24-28	
14	HSLA 420/500	0.76	3.2		420	430	500	530	22-26	
15	FB 450/600	1.8	3.0	A80	450	530	560	605	18-23	0.11
16	TRIP 450/800	1.0	1.6	A80	450	550	800	825	26-32	0.24
17	TWIP 450/1000	1.2		A50M	450	496	1000	1102	50-54	0.41*
18	HSLA 490/600	0.75	3.2		490	510	600	630	20-25	0.13
19	CP 500/800	0.8	1.6	A80	500		800		10-14	
20	DP 500/800	0.6	2.3	A50	500	520	800	835	14-20	0.14
21	HSLA 550/650	0.75	3.2	A50	550	586	650	676	19-23	0.12
22	SF 570/640				570		640		20-24	0.08
23	SF 600/780	2.9	5	A50	600	650	780	830	20-24	
24	DP 700/1000	0.6	2.3	A50	700	720	1000	1030	12-17	0.09
25	CP 800/1000	0.8	3.0	A80	800	845	1000	1005	8-13	0.11
26	MS 950/1200	1.5	3.2	A50M	950	960	1200	1250	5-7	0.07
27	CP 1000/1200	0.8	2.3		1000	1020	1200	1230	8-10	
28	HF 1050/1500 (22MnB5)									
	Conventional forming	1.0	2.5	A80	340	380	480	500	23-27	
	Heat treated after forming	1.0	2.5	A80	1050	1220	1500	1600	5-7	
29	MS 1150/1400	0.5	1.5	A50	1150	1200	1400	1420		
30	MS 1250/1520	0.5	1.5	A50M	1250		1520		4-6	0.07

\* Un-notched specimens,  $F_{Sc} = UTS + 345$  (Mpa)  
 Alternate approximation =  $3.45 \cdot HB$

**Table 1.14:** Range of steels available for FSV



### 1.12 Technology Assessment

From the steel portfolio, a primary formed blank or tube is produced from any of the following:

- Conventional single steel grade
- Laser welded blank
- Laser welded tube, both constant
- Laser welded coils
- High-frequency induction welded
- Variable walled tubes

The primary formed blank or tube, is then formed to the final part geometry using a number of manufacturing processes such as:

- Stamping
- Roll forming
- Hot stamping, both direct and in-direct
- Hydroforming

Figure 1.16 is a flow chart from the steel portfolio to the technology portfolio.

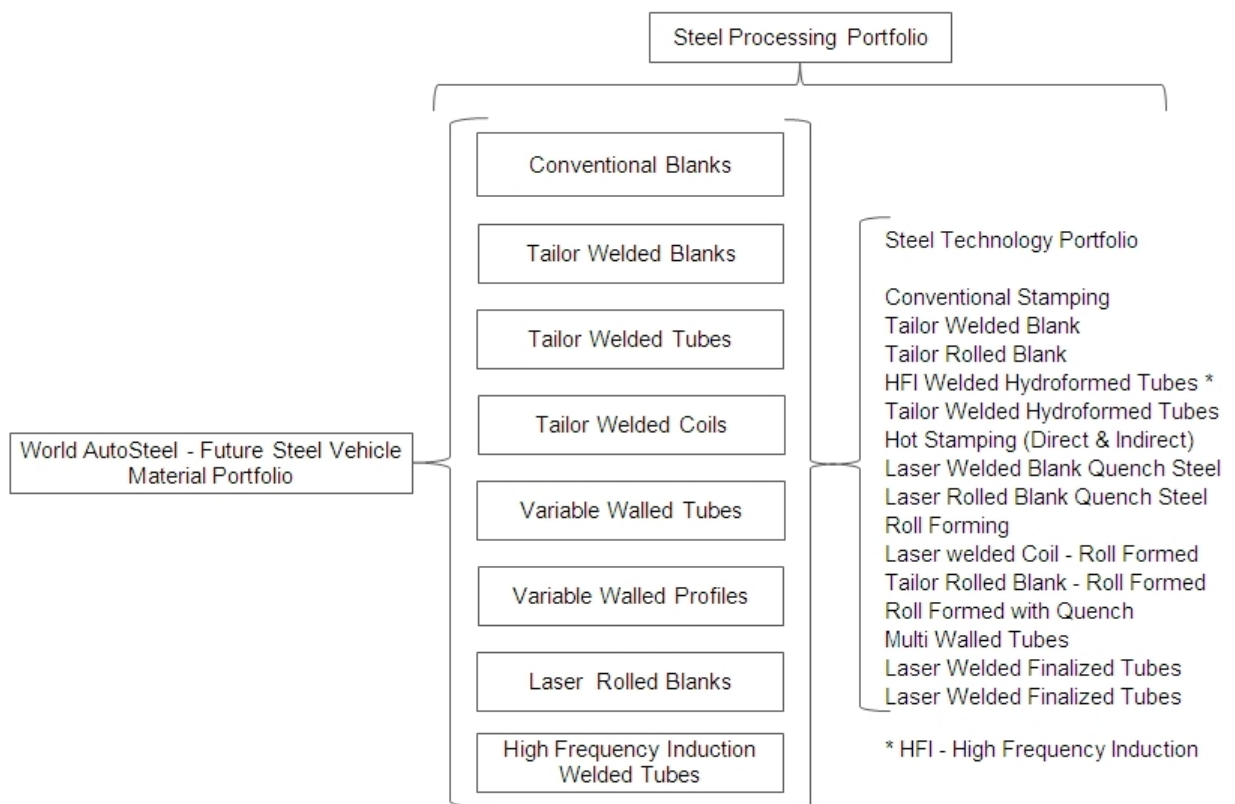

**Figure 1.16: Steel portfolio to technology portfolio flow diagram**

## 1.12.4 Automotive Technology Assessment

### 1.12.4.1 Drive-by-Wire

As a part of the engineering assessment on Drive-by-Wire systems as viable options for main-stream production on FSV-1 and FSV-2 by 2020, three types of Drive-by-Wire systems were looked at:

1. Brake-by-Wire
2. Throttle-by-Wire
3. Steer-by-Wire

Based on the research, the FSV engineering team strongly believes that of the three systems, only Brake-by-Wire and Throttle-by-Wire are viable production oriented technologies, as these provide a mass savings of approximately 3 kgs, and packaging advantages that significantly change the front-end structure of the vehicle while overcoming its current design challenges. “By-Wire systems” require robust and reliable 42V battery systems, and since both FSV-1 and FSV-2 have high-performance and high-voltage batteries as standard options, this technology provides a means for the FSV team to engineer optimized front-end packaging while reaping many other benefits of such a system.

At present, there are “partial” Brake-by-Wire systems that have some type of fail-safe hydraulic backup built into the system that provides minimal braking (limp home condition) in case of a complete electrical failure in the vehicle and/or the Brake-by-Wire system. However, all future development work currently being undertaken in terms of fault tolerant electronics in this regard, lead us to conclude that a complete Brake-by-Wire system with no hydraulic backup will be a production technology of the future (2020).

With the timeframe that FSV-1 and FSV-2 vehicles are targeted for production, The FSV engineering team believes that Steer-by-Wire is not a viable technology due to its inherent challenges in terms of safety and reliability of the system and its fault tolerance. The sizes of the components required are similar to a conventional steering system and the use of Steer-by-Wire does not lead to any significant mass saving. It is understood that at present, the use of a steering wheel is essential for regular high-speed driving. This necessitates similar structural mounting requirements as a conventional steering system to minimize vibrations, in addition to stiffness requirements, which in turn leads to locating the airbag in the steering wheel.

On the FSV structure, the positioning of the steering rack will not yield any additional packaging gains as the front length has been reduced to the minimum required to meet the 5-star NCAP crash rating.

### 1.12.4.2 Lightweight Components - Technical Assessment

Investigations of new automotive technologies on the horizon were investigated to assess the impact of mass reduction and packaging space implications without sacrificing vehicle function or safety. The reduction in trim and component mass generally leads to a total reduction in the vehicle's mass and also a reduction of body-structure mass (Mass Compounding).

The following automotive technologies were investigated:

- Glazing
- LED lighting
- Instrument panel displays
- Lightweight seating

Table 1.15 illustrates the compared component weight savings between conventional vehicles and the proposed Future Steel Vehicle, thus proving the FSV's considerable weight advantage.

Item	Generic Weight [kg]	FSV Weight [kg]	Mass Savings [%]
Glazing	44	31	29.5
Lighting	10	6.3	37
I/P Display	2.2	0.2	91
Seating	65	42	35.4
<b>Totals</b>	<b>121.2</b>	<b>79.5</b>	

<b>Mass Savings [kg]</b>	<b>41.7</b>
--------------------------	-------------

**Table 1.15:** *Component weight savings - conventional vehicles versus Future Steel Vehicle*

The compounding effect of a 41.7 kg weight savings on the vehicle and body is a mass reduction of 10 kg on the body-structure.

### 1.12.4.3 FSV Wheels and Tires

The FSV-1 and FSV-2 are designed to accept a 15-inch wheel. The specific tire size, wheel and mass for both vehicles are shown in Table 1.16.

Vehicle	Tire Size	Wheel Type	Mass [kg]	Mass [lbs]
FSV1	P175/65R15	Steel	14.1	31
FSV2	P175/65R15	Steel	14.1	31

**Table 1.16:** FSV wheels & tires

Low-rolling resistance tires are designed to improve the fuel efficiency of a vehicle by minimizing the energy wasted as heat as the tire rolls down the road. Tire companies are conducting significant research and development in this area as approximately 5-15% of the fuel consumed by a typical car is used to overcome rolling resistance of the tires.

A 2003 California Energy Commission (CEC) <sup>[2]</sup> preliminary study estimated that adoption of low-rolling resistance tires could save 1.5-4.5% of all gasoline consumption.

Rolling Resistance Coefficient (RRC) is the value of the rolling resistance force divided by the wheel load. A lower coefficient means the tires will use less energy to travel. The Society of Automotive Engineers (SAE) has developed test practices to measure the RRC of tires. These tests (SAE J1269 and SAE J2452) are usually performed on new tires. When measured by using these standard test practices, most new passenger tires have reported RRCs ranging from 0.008 to 0.014.

All calculations for FSV are assuming a RRC target equal to 0.007.

### 1.12.4.4 Auxiliary Equipment & Power Management Systems

As a part of the engineering assessment on new automotive technologies that are viable for production by the year 2020, the FSV engineering team assessed the impact of auxiliary equipment power demand loads on the vehicles performance and All Electric Range (AER).

A major portion of the auxiliary energy demand comes from the vehicle's air conditioning system, and our research has revealed that reducing this load significantly affects vehicle performance and range. A number of new technologies will be available for mainstream production for FSV-1 and FSV-2 by 2020 that will help reduce this parasitic load and provide FSV-1 and FSV-2 with enhanced performance and range.

The study has also led the team to conclude that reducing and optimizing A/C load may be the most efficient way of designing the propulsion system and battery to arrive at a very balanced (in

<sup>2</sup>Source:Chris Calwell, Travis Reeder, Technical report, Green Seal Environmental Partners, Inc., March 2003.

### 1.13 Future Safety Requirements

terms of cost and size) design while achieving the set performance targets. Studies conducted by leading national labs have shown that peak A/C loads reduce the range of an electric vehicle by as much as 38%.

In this study, a combination of proven methods and systems for FSV-1 and FSV-2 were used to achieve performance targets while maintaining optimized propulsion and power management systems. These methods and systems include the following:

- Advanced glazing (solar reflective glass)
- Solar reflective paint
- Cabin recirculation strategies (active sunroof ventilation)

### 1.13 Future Safety Requirements

The FSV engineering team conducted an assessment of proposed future (2010-2020) global safety regulations in comparison to the current requirements, with the intention to understand the implication of new regulations on the design of the FSV-1 and FSV-2, and to incorporate all the necessary structural changes on the FSV to meet and exceed these upcoming regulatory specifications by a comfortable safety margin.

The estimated mass, cost and fuel economy impacts of these new requirements (over vehicle lifetime) are shown in Table 1.17.

Regulation	Timeline	Mass	Cost [\$ US]	Fuel Used
Roof Crush/Rollover	2016	~ 2 kg	N/A	N/A
Electronic Stability Control (ESC)	2011	~ 1 kg	92.00	9.8 l (2.6 ga)
Pole Impact	2011	~ 6-8 kg	208.00	N/A
Frontal Impact	TBD	TBD	N/A	N/A
Bumper Impact	2008	1 kg	N/A	N/A
Ped-Pro	2011	1-2 kg	N/A	N/A

**Table 1.17:** *Estimated mass, cost and fuel economy impacts*







### 1.14 Fuel Economy Requirements

The results from our research into future fuel economy requirements have shown that most of the countries are currently working on regulations that mandate the amount of CO<sub>2</sub> emissions allowed for passenger cars.

On May 19 2009, the US EPA and California Air Resources Board (CARB) passed regulations that mandate the average fleet fuel economy to be 15.09  $\frac{\text{km}}{\text{l}}$  (35.5  $\frac{\text{miles}}{\text{gallon}}$ ) by 2016. The US government also unveiled new national auto standards that will accelerate increases in fuel economy, and impose the first-ever national Greenhouse Gas Emissions (GHG) standard on cars and trucks by comprehending the California proposal into US national law, and proposing to set a GHG limit of 155  $\frac{\text{g}(\text{CO}_2)}{\text{km}}$  (250  $\frac{\text{g}(\text{CO}_2)}{\text{m}}$ ) in 2016.

European regulations demand that the average passenger car fleet CO<sub>2</sub> emissions be within 130  $\frac{\text{g}(\text{CO}_2)}{\text{km}}$  by 2012, and proposals to reduce this number to 95  $\frac{\text{g}(\text{CO}_2)}{\text{km}}$  by the year 2020 are currently being discussed by the European Commission.

Summary of future fuel economy requirements is shown in Table 1.18.

CO <sub>2</sub> Emissions			Fuel Economy			
year		$[\frac{\text{g}(\text{CO}_2)}{\text{km}}]$	Gasoline		Diesel	
			[mpg]	[km/l]	[mpg]	[km/l]
2008		200	27.46	11.67	31.51	13.39
2008		160	34.33	14.59	39.39	16.74
2016		155	35.50	15.09	41.19	17.51
2012		130	42.25	17.96	48.48	20.60
2012		120	45.77	19.45	52.52	22.32
2020		95	57.82	24.57	66.34	28.20

**Table 1.18:** CO<sub>2</sub> emission requirements

Data source: US EPA<sup>[3]</sup>

<sup>3</sup>CO<sub>2</sub> emissions from a gallon of **gasoline** = 2,421 g x 0.99 x (44/12) = 8,788 g = 8.8 kg/gallon = 19.4 lbs/gallon  
CO<sub>2</sub> emissions from a gallon of **diesel** = 2,778 g x 0.99 x (44/12) = 10,084 g = 10.1 kg/gallon = 22.2 lbs/gallon



## List of Figures

1.1	Phase 1 - Engineering study: content & methodology . . . . .	2
1.2	Conventional ICE front-end . . . . .	5
1.3	FSV Electric drive front-end . . . . .	5
1.4	Compact Electric Drive . . . . .	6
1.5	Front-end rail . . . . .	6
1.6	PHEV <sub>20</sub> powertrain layout . . . . .	7
1.7	BEV underbody . . . . .	8
1.8	FSV-2 (PHEV <sub>40</sub> ) . . . . .	9
1.9	FSV-2 - FCEV . . . . .	10
1.10	FSV fuel economy and CO <sub>2</sub> emissions . . . . .	16
1.11	FSV-1 Pump-to-Wheel CO <sub>2</sub> emissions . . . . .	18
1.12	FSV-1 Well-to-Wheel CO <sub>2</sub> emissions . . . . .	19
1.13	FSV-2 Pump-to-Wheel CO <sub>2</sub> emissions . . . . .	20
1.14	FSV-2 Well-to-Wheel CO <sub>2</sub> emissions . . . . .	21
1.15	Fuel stack assembly . . . . .	25
1.16	Steel portfolio to technology portfolio flow diagram . . . . .	31

## List of Tables

1.1	FSV-1 and FSV-2 vehicle capacity . . . . .	3
1.2	Powertrain options & performance . . . . .	4
1.3	FSV-1 mass estimates (all in kg) . . . . .	11
1.4	FSV-2 mass estimates (all in kg) . . . . .	12
1.5	Cost of ownership, FSV-1 . . . . .	13
1.6	Cost of ownership, FSV-2 . . . . .	14
1.7	FSV fuel economy and CO <sub>2</sub> emissions table . . . . .	15
1.8	Well-to-Pump results (electricity generation) . . . . .	17
1.9	Powertrain mass, cost, fuel consumption, and GHG emissions . . . . .	22
1.10	Battery recommendation for FSV . . . . .	24
1.11	Fuel cell recommendation for FSV . . . . .	26
1.12	Electric motor recommendations for FSV . . . . .	27
1.13	Internal combustion engine recommendations - PHEV <sub>20</sub> and PHEV <sub>40</sub> . . . . .	28
1.14	Range of steels available for FSV . . . . .	30
1.15	Component weight savings - conventional vehicles versus Future Steel Vehicle . . . . .	33
1.16	FSV wheels & tires . . . . .	34
1.17	Estimated mass, cost and fuel economy impacts . . . . .	35
1.18	CO <sub>2</sub> emission requirements . . . . .	36